

2009

HospitalityMints

The perfect compliMINT, all wrapped up!



Made In America 



Over 30 years ago, a legacy of quality and perfection began and has flourished at Hospitality Mints- America's best candy company. Led by a management and sales team with 191 years of confection experience, Hospitality Mints manufactures over six million mints and candies a day.

We continue to work hard and strive for excellence. In the past two years, we have completely reconfigured and improved our 95,000 square foot manufacturing facility.

We have:

- New, state-of-the-art wrapping machines
- A new system for manufacturing soft candies that improved the creamy, buttery taste and, although the system flows in tiers if laid out, it is longer than a football field
- New, faster bagging equipment that has doubled our bagging capacity



- A new automatic case conveying system
- Engaged in Lean Manufacturing studies and analysis

In 2009, we are offering low cost brand impressions, improved lead times, fast deliveries, friendly and knowledgeable customer service and delicious, creamy, fresh candies from an American company that you can trust.

Made In America 



Table of Contents



Custom Individual Packaging	Pages 2-3
Wrap up your favorite logo with your favorite flavor.	
Custom Individual Packaging Pricing	Page 4
Custom Wedding Packaging	Page 5
A tasteful way to commemorate a very "Special Day."	
Stock Individual Packaging & Pricing	Pages 6-7
Choose from our broad assortment of stock logos.	
Custom Hospitality Packs	Page 8
Five delicious pieces of candy in one package with a custom imprint.	
Bagging	Page 9
Special bagging now available.	
Soft Candies	Page 10
Ten delightful flavors of buttery, creamy mints and candies.	
Assorted Gourmet Chocolate Mints	Soft Peppermints
Buttermints	Jelly-Filled Mints
Chocolate Mint Creams	Oranges & Cream
Pastel Buttermints	Strawberries & Cream
White Gourmet Chocolate Mints	Raspberries & Cream
Hard Candies	Page 11
Eight tantalizing treats drenched with sugar and tasty pizzazz.	
Hard Peppermint Balls	Spearmint Starlites
Assorted Fruit Balls	Red Peppermint Starlites
Hard Cinnamon Balls	Green Peppermint Starlites
Sugar Free Breath Mints	Cinnamon Starlites
Custom Breath Mint Tins	Pages 12-13
Custom imprinted breath mint tins, filled with sugar free breath mints.	
Window Pouch Bags	Page 14
Special gift packaging for any occasion.	
Products to Promote Your Business	Page 15
Art Specifications & Imprint Dimensions	Page 16
Product Specifications & Special Requests	Page 17

Custom Hotstamp Packaging



- One color imprint • Front side only • Minimum order: one case
- See page 4 for details!

Custom Pre-Printed Film (Flexography)



• Up to three color imprint • Front and back • Minimum order: ten cases
See page 4 for details!

Custom Individual Packaging Pricing

• **LEAD TIME NEW ORDERS: 11 working days plus shipping pending art approval.**

• **LEAD TIME REORDERS: 6 working days plus shipping.**

• **LEAD TIMES MAY VARY! During peak production, add 3 to 5 days. During slow production, you may receive your order more quickly.**

• **Plate Charge:** \$60 (V) per color

• **Wrappers:** Wrapper colors other than white and clear, \$10 (V) per case

• **Drop Ship Fee:** \$10 (V) per additional location

*If you wish to print on a tinted wrapper, the color of the wrapper counts as one color; i.e., yellow wrapper with red ink and black ink equals three colors.

• **Rush Service:** \$60 (V) for new art, \$35 (V) for reorders

• **Reorder Set-up Fee:** \$10 (V) per color

• **Paper Proofs:** No charge new art, please specify email address or fax number to send proof

• **Change Order Fee:** \$10 (V) per change within an order, such as ink and wrapper colors, flavor change, address change, etc.

• **The Following Require a Ten Case Minimum:**

Two & Three Color Imprints (\$60.00 (V) plate charge per color)

PMS Match Wrappers (\$10.00 (V) per case)

PMS Match Inks & Front & Back Imprints (No Charge)

PMS Match may be up to two shades off, we can not guarantee perfect match

Soft Candies 2PQR3S		Case Count	1 Case	3 Cases	5 Cases	10 Cases	15 Cases	20 Cases	40 Cases
STRAW	Strawberries & Cream	1,000	\$79.40	\$76.25	\$60.70	\$55.00	\$49.35	\$48.10	\$40.75
ORN	Oranges & Cream	1,000	\$79.40	\$76.25	\$60.70	\$55.00	\$49.35	\$48.10	\$40.75
RASP	Raspberries & Cream	1,000	\$79.40	\$76.25	\$60.70	\$55.00	\$49.35	\$48.10	\$40.75
BUTR	White Buttermints	1,000	\$79.40	\$76.25	\$60.70	\$55.00	\$49.35	\$48.10	\$40.75
APAS	Pastel Buttermints	1,000	\$79.40	\$76.25	\$60.70	\$55.00	\$49.35	\$48.10	\$40.75
SOPE	Soft Peppermints	1,000	\$79.40	\$76.25	\$60.70	\$55.00	\$49.35	\$48.10	\$40.75
JELL	Jelly-Filled Mints	1,000	\$81.60	\$78.45	\$62.40	\$56.60	\$51.90	\$49.35	\$42.25
GOCHW	White Gourmet Chocolate Mints	1,000	\$84.95	\$81.90	\$72.45	\$63.80	\$57.35	\$54.85	\$48.95
GOCH	Asst. Gourmet Chocolate Mints	1,000	\$84.95	\$81.90	\$72.45	\$63.80	\$57.35	\$54.85	\$48.95
CHOC	Chocolate Mint Creams	650	\$96.00	\$94.30	\$68.90	\$60.85	\$54.40	\$49.35	\$40.75

Hard Candies 2PQR3S		Case Count	1 Case	3 Cases	5 Cases	10 Cases	15 Cases	20 Cases	40 Cases
HPEP	Hard Peppermint Balls	1,000	\$79.40	\$76.25	\$60.70	\$55.00	\$49.35	\$48.10	\$40.75
HCIN	Hard Cinnamon Balls	1,000	\$79.40	\$76.25	\$60.70	\$55.00	\$49.35	\$48.10	\$40.75
FRBA	Assorted Fruit Balls	1,000	\$79.40	\$76.25	\$60.70	\$55.00	\$49.35	\$48.10	\$40.75
SUFR	Sugar Free Breath Mints	1,000	\$79.40	\$76.25	\$60.70	\$55.00	\$49.35	\$48.10	\$40.75
PSWL	Red Peppermint Starlites	1,000	\$79.40	\$76.25	\$60.70	\$55.00	\$49.35	\$48.10	\$40.75
PSWLG	Green Peppermint Starlites	1,000	\$79.40	\$76.25	\$60.70	\$55.00	\$49.35	\$48.10	\$40.75
CSWL	Cinnamon Starlites	1,000	\$79.40	\$76.25	\$60.70	\$55.00	\$49.35	\$48.10	\$40.75
SSWL	Spearmint Starlites	1,000	\$79.40	\$76.25	\$60.70	\$55.00	\$49.35	\$48.10	\$40.75

Wrapper Colors

Wrappers, other than white and clear, \$10.00(V) per case.

	Lime Green Wrapper (PMS 376)
	Kelly Green Wrapper (PMS 347)
	Hunter Green Wrapper (PMS 3305)
	Yellow Wrapper (PMS 115)
	Orange Wrapper (PMS 1585)
	Brown Wrapper (PMS 4975)
	Ivory Wrapper (PMS 7499)
	Metallic Gold Wrapper
	Metallic Silver Wrapper (recommended black ink only)
	White Wrapper
	Black Wrapper
	Red Wrapper (PMS 187)
	Burgundy Wrapper (PMS 221)
	Pink Wrapper (PMS 1767)
	Purple Wrapper (PMS 2613)
	Royal Blue Wrapper (PMS 286)
	Light Blue Wrapper (PMS 2905)
	Navy Blue Wrapper (PMS 281)
	Aqua Wrapper (PMS 637)
	Clear Wrapper (not available for Chocolate Mint Creams) Colors may vary and may not be an exact match

Ink Colors

No charge for inks!

	White Ink
	Red Ink (PMS 187)
	Burgundy Ink (PMS 216)
	Purple Ink (PMS 2613)
	Navy Blue Ink (PMS 281)
	Blue Ink (PMS 286)
	Green Ink (PMS 3425)
	Orange Ink (PMS 1585)
	Brown Ink (PMS 4975)
	Black Ink
	Gold* Ink (PMS 873)
	Bronze* Ink (PMS 876)
	Silver* Ink (PMS 877)
	Pink Ink (PMS 223)
	Lime Green (PMS 376)

*Hotstamp-Metallic, Flexography-Matte

Wedding Packaging & Pricing



1. **Select A Layout:** A. names & date only B. interlocking hearts C. cross with rings
 D. cake E. floral bands F. wedding bells
 G. initial H. polka dots J. create your own (not shown)

2. **Select A Typestyle:** *Amazone: Aa Bb Cc Dd Ee Ff Gg Hh Ii Jj Kk Ll Mm Nn Oo Pp Qq Rr Ss Tt Uu Vv Ww Xx Yy Zz &*
Benguiat Aa Bb Cc Dd Ee Ff Gg Hh Ii Jj Kk Ll Mm Nn Oo Pp Qq Rr Ss Tt Uu Vv Ww Xx Yy Zz &
Bible Script: Aa Bb Cc Dd Ee Ff Gg Hh Ii Jj Kk Ll Mm Nn Oo Pp Qq Rr Ss Tt Uu Vv Ww Xx Yy Zz &
Commerical Script: Aa Bb Cc Dd Ee Ff Gg Hh Ii Jj Kk Ll Mm Nn Oo Pp Qq Rr Ss Tt Uu Vv Ww Xx Yy Zz &
Dorchester Script: Aa Bb Cc Dd Ee Ff Gg Hh Ii Jj Kk Ll Mm Nn Oo Pp Qq Rr Ss Tt Uu Vv Ww Xx Yy Zz &
English Vivance: Aa Bb Cc Dd Ee Ff Gg Hh Ii Jj Kk Ll Mm Nn Oo Pp Qq Rr Ss Tt Uu Vv Ww Xx Yy Zz &
Flemish Script: Aa Bb Cc Dd Ee Ff Gg Hh Ii Jj Kk Ll Mm Nn Oo Pp Qq Rr Ss Tt Uu Vv Ww Xx Yy Zz &
Murray Hill: Aa Bb Cc Dd Ee Ff Gg Hh Ii Jj Kk Ll Mm Nn Oo Pp Qq Rr Ss Tt Uu Vv Ww Xx Yy Zz &
Tiffany: Aa Bb Cc Dd Ee Ff Gg Hh Ii Jj Kk Ll Mm Nn Oo Pp Qq Rr Ss Tt Uu Vv Ww Xx Yy Zz &
Windsor: Aa Bb Cc Dd Ee Ff Gg Hh Ii Jj Kk Ll Mm Nn Oo Pp Qq Rr Ss Tt Uu Vv Ww Xx Yy Zz &

3. **Select An Imprint Color:** Black, Royal Blue, Navy Blue, Bronze, Metallic Gold, Brown, Burgundy, Metallic Silver, Hunter Green, White, Orange, Pink, Purple, Red, Lime Green

4. **Select A Wrapper Color:** White, Clear, Black, Light Blue, Aqua, Navy Blue, Royal Blue, Burgundy, Metallic Gold, Hunter Green, Kelly Green, Ivory, Lime Green, Pink, Purple, Red, Metallic Silver, Yellow, Brown, Orange,

5. **Specify Your Imprint:** **Name(s):** _____
Date: _____

6. **Select Method of Payment: Credit Card #:** _____
 Prepayment required on a first time order (COD - extra handling charges apply)

7. **Ship To:** _____ **Bill To:** _____

Phone #: _____ **Fax #:** _____

8. **Method:** UPS unless otherwise indicated

9. **Date Needed:** _____

10. To "Create Your Own," please send camera ready artwork.

11. Select item(s) to be ordered below & send to Hospitality Mints art@hospitalitymints.com. Turn around time is 11 working days plus shipping. Rush service available for \$60.00(V).

Cases Ordered	Case Count	Candy Flavor	Price per Case	Total
_____	500	Soft Peppermints	\$84.00(P)	_____
_____	500	White Buttermints	\$84.00(P)	_____
_____	500	White Gourmet Chocolate Mints	\$84.00(P)	_____
_____	650	Chocolate Mint Creams	\$95.00(P)	_____
		Shipping & Handling/cs (within the continental US)	\$7.50/cs	_____
		Plate Charge	\$60.00(V)	_____
		TOTAL		_____

WED (500 or 650 case count)

Stock Packaging



American Flag
Item Code: FLAG



Back to School
2 Assorted Wrappers
Item Code: BTS



Christmas Assortment
4 Assorted Wrappers
Item Code: XMAS/ASST



Confetti
Item Code: CONF



Cosmic Flower
Item Code: COSMIC



Happy Holidays
Item Code: HH



Hugs & Kisses
4 Assorted Wrappers
Item Code: HUGS



Irish
4 Assorted Wrappers
Item Code: IRISH



Lady Bug
4 Assorted Wrappers
Item Code: LADY



Mardi Gras
4 Assorted Wrappers
Item Code: MARDI



Money
4 Assorted Wrappers
Item Code: MONEY



One Love
4 Assorted Wrappers
Item Code: ONE



(Can be imprinted with any of our standard ink colors)

Pink Ribbon Item Code: PINK
Smiley Face Item Code: SMILE



Season's Greetings
4 Assorted Wrappers
Item Code: SGR



Snowman
4 Assorted Wrappers
Item Code: SNOW



Squiggly Heart
Item Code: STK
(Can be imprinted with any of our standard ink colors)

Stock Packaging & Pricing



Thank You

Item Code: STK
(Can be imprinted with any of our standard ink colors)



Thanks A Mint - Classic

Item Code: TAM



Thanks A Mint - Foil Lined

Item Code: THM



Thanks for Sharing Our Special Day

Item Code: TSSD
(Can be imprinted with any of our standard ink colors)



Tropical Fun

4 Assorted Wrappers
Item Code: TROPICAL



We Love Our Customers

Item Code: STK
(Can be imprinted with any of our standard ink colors)



We Love Our Members

Item Code: STK
(Can be imprinted with any of our standard ink colors)

Stock Packaging is Ideal For:

Fillers for containers such as gift tins, candy jars, and coffee mugs

Seasonal holidays and special occasions

Parades and community events

Table confetti for business dinners and conventions

Employee giveaways

Tight budgets

Shorter lead times

- **Lead Time:** 6 working days plus shipping from receipt of purchase order
- **LEAD TIMES MAY VARY!** During peak production, add 3 to 5 days. During slow production, you may receive your order more quickly.
- **No Plate Charge**
- **No Set-up Fee**
- **Rush Service:** \$35 (V)
- **Drop Ship Fee** \$10 (V) per additional location
- **Stock Designs Only** (may not be customized)

- **All stock orders are made "to order" based on wrapper design and candy type**
- **Stock wrappers featured on pages 6 & 7 are available ONLY in the following candies: White Buttermints, Soft Peppermints, Assorted Gourmet Chocolate Mints, Chocolate Mint Creams and Assorted Fruit Balls**
- **Any other combination of wrapper and/or candy is considered "Custom."** Please see page 4 for Custom Pricing.

Soft Candies	3P3Q1R	Case Count	1 Case	3 Cases	5 Cases	10 Cases	15 Cases	20 Cases	40 Cases
BUTR	White Buttermints	1000	\$51.90	\$51.90	\$49.15	\$43.50	\$43.50	\$40.75	\$36.10
SOPE	Soft Peppermints	1000	\$51.90	\$51.90	\$49.15	\$43.50	\$43.50	\$40.75	\$36.10
GOCH	Asst. Gourmet Chocolate Mints	1000	\$75.00	\$75.00	\$61.75	\$53.15	\$51.05	\$49.15	\$40.10
CHOC	Chocolate Mints Creams	650	\$56.30	\$56.30	\$54.00	\$48.55	\$47.90	\$46.85	\$39.30

Hard Candies	3P3QR	Case Count	1 Case	3 Cases	5 Cases	10 Cases	15 Cases	20 Cases	40 Cases
FRBA	Assorted Fruit Balls	1000	\$51.90	\$51.90	\$49.15	\$43.50	\$43.30	\$40.75	\$36.10

Custom Hospitality Packs



Five Pieces of Candy per Pack

- **Minimum Order:** Two cases per flavor, 400 packs total
- **Case Pack:** 200 packs per case
- **Pieces of Candy per Pack:** 5
- **Candy Flavors:** Buttermints, Soft Peppermints, Gourmet Chocolate Mints, Chocolate Mint Creams, and Assorted Fruit Balls
- **Cannot assort flavors within case.**
- **Ink Colors:** Black, Blue, Brown, Matte Bronze, Matte Gold, Matte Silver, Burgundy, Green, Pink, Orange, Purple, Red, & Lime Green. PMS match available, no metallics. PMS match may be up to two shades off, we can not guarantee perfect match
- **Plate Charge:** \$60.00 (V) per color, up to three colors
- **Flavor Change Plate Charge:** \$25.00 (V)
- **Pack Size:** Approximately 3" x 3 1/2"
- **Imprint Area:** 2" x 1 1/2"
- **Wrapper Color:** White ONLY (no additional charge)
- **Reorder Set-up Fee:** \$10 (V) per color
- **Change Order Fee:** \$10 (V) per change in an order, such as ink color, flavor change, address change, etc.
- **Drop Ship Fee:** \$10 (V) per additional location
- **Rush Service:** \$60 (V) for new art, \$35 (V) for reorders
- **Shipping Weight:** 10 lbs. per case
- **Lead Time New Orders:** 11 working days plus shipping pending art approval.
- **Lead Time Reorders:** 6 working days plus shipping.
- **LEAD TIMES MAY VARY! During peak production, add 3 to 5 days. During slow production, you may receive your order more quickly.**
- **Extended Shelf Life:** 4 months

Unit Price Per Case 6R (per case)		2 Cases	5 Cases	10 Cases	15 Cases	20 Cases	40 Cases
BUTR-PAC-CUS	Buttermints	\$82.70	\$74.45	\$70.30	\$66.15	\$62.10	\$57.95
FRBA-PAC-CUS	Asst. Fruit Balls	\$82.70	\$74.45	\$70.30	\$66.15	\$62.10	\$57.95
SOPE-PAC-CUS	Soft Peppermints	\$82.70	\$74.45	\$70.30	\$66.15	\$62.10	\$57.95
CHOC-PAC-CUS	Chocolate Mints Creams	\$99.25	\$95.15	\$91.00	\$88.55	\$82.70	\$78.60
GOCH-PAC-CUS	Asst. Gourmet Chocolates	\$91.00	\$86.85	\$82.70	\$80.25	\$76.95	\$74.45

Bagging

Allows you to divide cases. Controls usage.
Provides refill inserts for fulfillment programs.

50 Count Bag New Clear Film



- **Pieces per Pack:** Approximately 50
- **Bag Dimensions:** Approximately 8" wide and 8" long
- **Clear, polypropylene film used for bag**
- **Bagging Charge per Bag, 1-9 cases:** \$1.10 (P)
- **Bagging Charge per Bag, 10 plus cases:** \$0.90 (P)
- **Chocolate Mint Cream only available in 50-ct bags**

100 Count Bag New Clear Film



- **Pieces per Pack:** Approximately 100
- **Bag Dimensions:** Approximately 8" wide and 10" long
- **Clear, polypropylene film used for bag**
- **Bagging Charge per Bag, 1-9 cases:** \$1.10 (P)
- **Bagging Charge per Bag, 10 plus cases:** \$0.90 (P)

125 Count Bag 1 lb. Bags New Clear Film



- **Pieces per Pack:** Approximately 125 (1 lb.)
- **Bag Dimensions:** Approximately 8" wide and 11" long
- **Clear, polypropylene film used for bag**
- **Bagging Charge per Bag, 1-9 cases:** \$1.10 (P)
- **Bagging Charge per Bag, 10 plus cases:** \$0.90 (P)

250 Count Bag and 500 Count Bag



- **Pieces per Pack:** Approximately 250 or 500
- **Twist Tie**
- **Cloudy-like, polyethylene film used for bag**
- **Bagging Charge per Bag, 1-9 cases:** \$1.10 (P)
- **Bagging Charge per Bag, 10 plus cases:** \$0.90 (P)

- **Lead Time - ALL New Bagging Orders:** 14 working days plus shipping after receipt of order and approved art.
- **Lead Time - ALL Bagging Reorders:** 9 working days plus shipping pending art approval.
- **LEAD TIMES MAY VARY! During peak production, add 3 to 5 days. During slow production you may receive your order more quickly.**

Soft Candies



All chocolate will melt in sustained high temperatures.
We reserve the right not to ship during heat waves.

A: Soft Peppermints

Reminiscent of an old-fashioned peppermint stick, a delightful melt-in-your mouth treat.

B: Oranges & Cream

Dreamy and sweet, deliciously creamy.

C: Jelly-Filled Mints

Delightful jellies in lemon, mint and orange, wrapped inside creamy Buttermints.

D: Raspberries & Cream

Fruity raspberry flavor blended with buttery richness.

E: Buttermints

Hospitality Mints' best selling candy...cool, creamy mint blended with buttery richness.

F: Strawberries & Cream

Creamy, smooth and bursting with strawberry flavor.

G: Chocolate Mint Creams

A taste-tempting combination of ultra-rich chocolate and creamy, smooth Buttermints. (Clear wrap not available.)

H: Pastel Buttermints

Classic Buttermints in soft pastels...pink, yellow, green and white.

I: Assorted Gourmet Chocolate Mints

Delicious Buttermints dipped in dark chocolate, coupled with bright sweet candy coatings.

J: Gourmet Chocolate Mints/White Candy Shell

Our famous Buttermints drenched in luscious dark chocolate, topped with a sweet white candy coating.

Available in large wrapper only.

Shelf Life: 4 months

Hard Candies



K: Hard Cinnamon Balls**

Great cinnamon flavor and spicy pizzazz.

L: Spearmint Starlites*

A savory mint full of great tasting flavor.

M: Hard Peppermint Balls**

Generously laden with peppermint, an all time favorite.

N. Red Peppermint Starlites*

A burst of freshness in a classic mint taste.

O: Assorted Fruit Balls**

Great fruity flavors in sour cherry, sour tangerine and sour green apple.

P: Cinnamon Starlites*

Spunky and spicy, delicious cinnamon mints.

Q: Sugar Free Peppermint Breath Mints**

Fresh, cool flavor without the sugar.

R: Green Peppermint Starlites*

Fresh and minty.

***Available in large wrapper for 1-9 cases and small wrapper for 10 plus cases.**

**** Available in large wrapper only.**

Shelf Life: 6 months



Custom Breath Mint Tins

**Custom Flavors Available.
Call for Details!**



Custom Breath Mint Tins

12

Unit Price Per Tin 8R	100	300	500	1,000	2,000	5,000	10,000	15,000
STIN, STINC, STINW	\$3.15	\$3.00	\$2.80	\$2.40	\$2.25	\$2.10	\$1.85	\$1.75
HEARTP, HEARTC, HEARTW	\$3.60	\$3.45	\$3.30	\$3.00	\$2.65	\$2.55	\$2.35	\$2.25
STARSP, STARSC, STARSW	\$3.60	\$3.45	\$3.30	\$3.00	\$2.65	\$2.55	\$2.35	\$2.25

Ⓢ Must be ordered in multiples of 100

Shelf Life: 8 to 12 months

Custom Breath Mint Tins

Custom Flavors Available. Call for Details!

SMALL BREATH MINT TINS

- **Plate Charge:** \$60 (V) one time charge
- **Reorder Set-up Fee:** \$10 (V)
- **Drop Ship Fee:** \$10 (V) per additional location
- **Change Order Fee:** \$10 (V) per change within an order, such as breathmint, tin, ink, address, etc.
- **Lead Time New Orders:** 11 working days plus shipping pending art approval.
- **Lead Time Reorders:** 6 working days plus shipping.
- **Lead Times may be extended during peak production 3 to 5 days**
- **Size of Tin:** 2 1/4" x 1 3/4" x 5/8"
- **Paper Proof:** No charge, please specify email address or fax number to send proof
- **Colors:** White or Silver
- **Net Weight:** .45 ounces (approximately 38 mints)
- **Imprint Area:** 1 3/4" x 1 1/2"
- **White or metallic inks not available.**
- **Sugar Free Breath Mint Flavors:** Tablet-shaped, Peppermint, Cinnamon, or Wintergreen
- **Rush Service:** \$60 (V) for new art, \$35 (V) for reorders
- **Minimum Order:** One case, 100 tins
- **Case Pack:** 100 tins
- **Case Weight:** 8 lbs. / 100 tins
- **STIN** (Peppermint, 100 case count)
- **STINC** (Cinnamon, 100 case count)
- **STINW** (Wintergreen, 100 case count)

HEART BREATH MINT TINS

- **Plate Charge:** \$60 (V) one time charge
- **Reorder Setup Fee:** \$10 (V)
- **Drop Ship Fee:** \$10 (V) per additional location
- **Change Order Fee:** \$10 (V) per change within an order, such as breathmint, tin, ink, address, etc.
- **Lead Time New Orders:** 11 working days plus shipping pending art approval.
- **Lead Time Reorders:** 6 working days plus shipping.
- **Lead Times may be extended during peak production 3 to 5 days**
- **Size of Tin:** 1 7/8" x 1 5/8" x 1"
- **Paper Proof:** No charge, please specify email address or fax number to send proof
- **Imprint Area:** 1" x 3/4"
- **Color:** Red
- **Net Weight:** .58 ounces (approximately 41 mints)
- **White or metallic inks not available.**
- **Black ink only on red tins.**
- **Sugar Free Breath Mint Flavors:** Tablet-shaped Peppermint, Cinnamon, or Wintergreen,
- **Rush Service:** \$60 (V) for new art, \$35 (V) for reorders
- **Minimum Order:** One case, 100 tins
- **Case Pack:** 100 tins
- **Case Weight:** 10 lbs. / 100 tins
- **HEARTP** (Peppermint, 100 case count)
- **HEARTC** (Cinnamon, 100 case count)
- **HEARTW** (Wintergreen, 100 case count)

STAR BREATH MINT TINS

- **Plate Charge:** \$60 (V) one time charge
- **Reorder Setup Fee:** \$10 (V)
- **Drop Ship Fee:** \$10 (V) per additional location
- **Change Order Fee:** \$10 (V) per change within an order, such as breathmint, tin, ink, address, etc.
- **Lead Time New Orders:** 11 working days plus shipping pending art approval.
- **Lead Time Reorders:** 6 working days plus shipping.
- **Lead Times may be extended during peak production 3 to 5 days**
- **Size of Tin:** 3 1/2" x 2 3/4" x 9/16"
- **Paper Proof:** No charge, please specify email address or fax number to send proof
- **Colors:** White or Silver
- **Net Weight:** .58 ounces (approximately 41 mints)
- **Imprint Area:** 1 1/2" x 1 1/4"
- **White or metallic inks not available.**
- **Sugar Free Breath Mint Flavors:** Star-shaped, Peppermint, Cinnamon, or Wintergreen
- **Rush Service:** \$60 (V) for new art, \$35 (V) for reorders
- **Minimum Order:** One case, 100 tins
- **Case Pack:** 100 Tins
- **Case Weight:** 10 lbs. / 100 tins
- **STARSP** (Star-shaped Peppermint, 100 case count)
- **STARSC** (Star-shaped Cinnamon, 100 case count)
- **STARSW** (Star-shaped Wintergreen, 100 case count)

Must be ordered in multiples of 100

Window Pouch Bags



5.5 oz Resealable Gift Bags Approximately 40 Pieces Per Bag with Customized Gift Tag

- **Candy:** Buttermints and Assorted Gourmet Chocolates
- **Bag Colors:** Red, Black, Gold Oval or Blue
- **Or Select a Printed Seasonal Bag:** Halloween, Flag, Christmas or Gold Star
- **Ribbon Colors:** Red, Black, Royal Blue, Cream, White or Gold Star
- **Dimensions of the Bag:** 5" width, 7" height
- **Card Colors:** White or Cream
- **Case Pack:** 24 Bags
- **Customized Gift Tag:** Four-color process imprint available. Imprint area per panel: 2 1/4" x 2 1/4". Printing available on two panels only. Ingredients and nutrition facts printed on back of card. PMS match will vary. Please indicate ink colors.
- **Shelf Life:** 8 months
- **Plate Charge:** \$60 (V) per order
- **Minimum Order:** 24 bags, must order in multiples of 24
- **Reorder Set-up Fee:** \$10 (V)
- **Rush Charge:** \$60 (V) for new art, \$35 (V) for reorders
- **Drop Ship Fee:** \$10 (V) per additional location
- **Change Order Fee:** \$10 (V) per change within an order, such as candy, bag, ribbon, address, etc.
- **Net Weight:** 5.5 oz per bag
- **Case Weight:** 10 lbs.
- **Lead Time New Orders:** 11 working days plus shipping pending art approval.
- **Lead Time Reorders:** 6 working days plus shipping.
- **LEAD TIMES MAY VARY!** During peak production, add 3 to 5 days. During slow production you may also receive your orders more quickly.

Unit Price Per Bag 2P2R		24 Bags	72 Bags	240 Bags	360 Bags
BUTR-ZIP-CUS	Buttermints	\$5.30	\$4.80	\$3.70	\$3.15
GOCH-ZIP-CUS	Asst. Gourmet Chocolates	\$5.80	\$5.30	\$3.95	\$3.70

Must be ordered in multiples of 24

2009 When and Who to Sell Mints

I'm Tina Jameson-Brown, Hospitality Mint's National Sales Manager. At Hospitality Mints, we provide affordable food gifts/marketing tools for as little as pennies per serving. For every program that you coordinate with your clients, remember to "add-on" custom or stock products from Hospitality Mints or sell them as a "stand alone" program. Our products are ideal for the following purposes and prospects:

- Finance
- Health/Healthcare
- Ad Agencies/Marketing Efforts
- Schools/Education
- Political/Civic
- Manufacturing
- Automotive
- Charity Promotions
- Real Estate
- Property Management
- Brand Awareness/New Product Launch
- Business Calls
- Spas and Beauty Care
- Company Stores
- Corporate/Business
- Customer Referrals
- Employee Appreciation and Safety
- Employee Relations and Events
- Churches
- Contractors
- Accounting Firms
- Law Firms
- Trade Shows
- Public Relations



Check it out!
Improved lead times!

Art Specifications

Hotstamp Image Area: Less than ten cases of candy, front only imprint, and/or metallic gold or metallic silver ink. Available in all flavors.

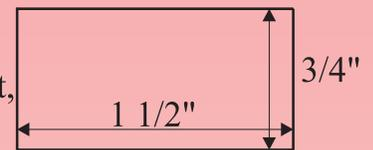

Flexography Large Wrapper Image Area: Ten case minimum, up to three color imprint, front and back imprint, PMS matches. Metallic inks not available. Available in all flavors.

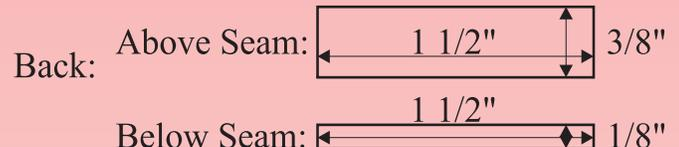
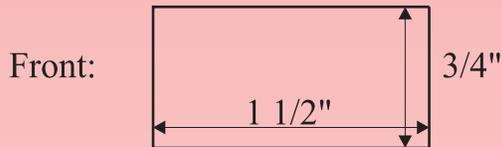

Flexography Small Wrapper Image Area: Ten case minimum, up to three color imprint, front and back imprint, PMS matches. Metallic inks not available. **Wrappers only available in white.** This wrapper is only used for small candies such as Starlites.

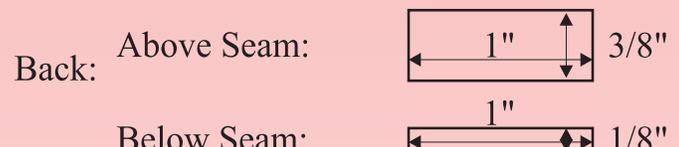
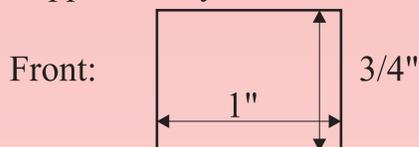

Hospitality Pack Image Area: Two case minimum, up to three color imprint, PMS matches. Metallic inks not available. **Wrappers only available in white.** Limited candy flavors available.

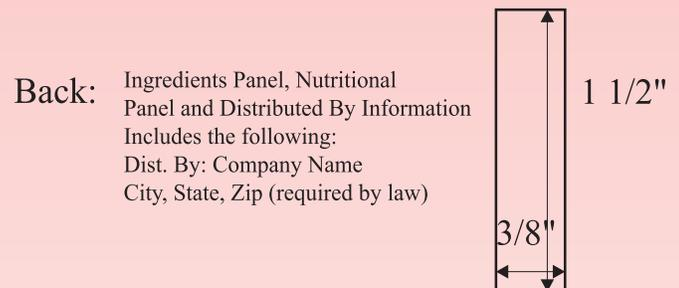
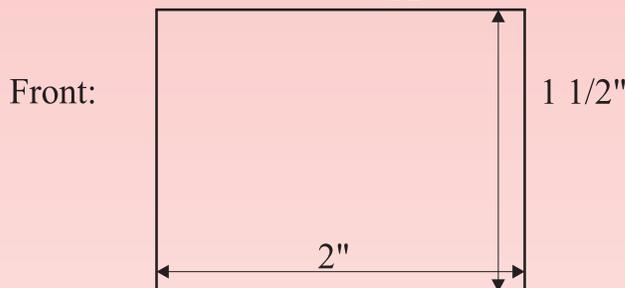

Breath Mint Tin Image Area: Four color process printing on top of tins only with a 50% maximum imprint coverage limit. White or metallic inks are not available. Imprint screens are available from 30% to 80%. Small and star tins are available in white and silver, heart tins in red and white.

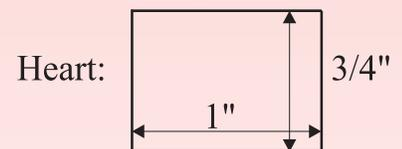
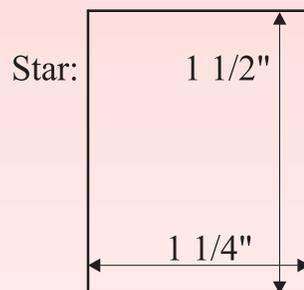
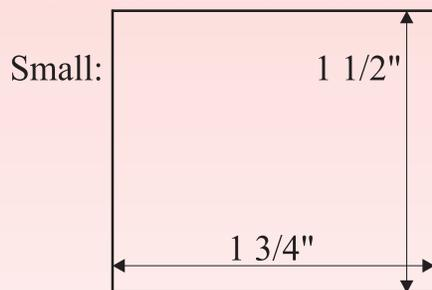

Gift Tag Image Area: Four color process printing on two panels of cards. White or metallic inks are not available. Imprint screens are available from 30% to 80%. Cards are available in white and cream.

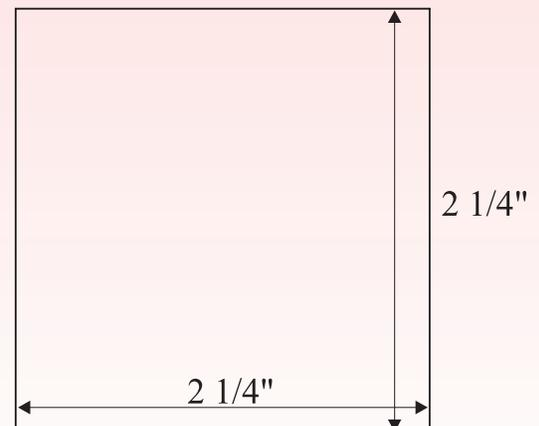

Product Specifications

Made In America 

SAMPLES: Standard Sample Kit includes variety of candies and wrappers, small tin, Hospitality Pack, catalog \$6.25 (V); Gift Bag Sample Kit includes one random Window Pouch Bag, catalog \$6.25 (V); One specified Window Pouch Bag 6.25 (V); catalogs up to ten no charge, additional catalogs \$1.25 (V) each. Price includes freight, credit card only, Postal/Standard. Rush Charge: \$10 (V).
Leadtime: 3 working days plus shipping.

IMPROVED PRODUCTION TIMES: New orders-Custom imprint 11 working days plus shipping pending art approval. Stock imprint/no imprint 6 days plus shipping. Hospitality Packs new orders-11 working days plus shipping pending art approval. Hospitality Packs reorder-6 working days plus shipping. Tins new orders-11 working days plus shipping pending art approval. Tins reorders-6 working days plus shipping. Window Pouch Bags new art-11 working days plus shipping pending art approval. Window Pouch Bags reorders-6 working days plus shipping. Rush Service-new orders \$60(V), reorders \$35(V), call Customer Service for delivery times. Please allow 48 hours for your order to be entered into our system. Lead times may vary! During peak production add 3-5 days. During slow production, you may receive your order more quickly.

SHELF LIFE: Soft candies-four months, hard candies and foil Thanks A Mint-six months, window bags-eight months.

MINIMUM: One case for individually wrapped one side imprint with one-color standard ink. Ten cases for individually wrapped two or three color imprints, front and back imprints, PMS match imprints, PMS match wrappers. One case of 100 for small tins, star tins or heart tins. Two cases of 400 total (200 packs per case) Hospitality Packs. One case of 24 window pouch bags.

SHIPPING WEIGHT: Chocolate Mint Creams: 8 lbs., case count 650; All Starlites: 8 lbs., case count 1,000; Gourmet Chocolate Mints: 7 lbs., case count 1,000; Sugar Free Breath Mints: 6 lbs., case count 1,000; Fruit Balls: 11 lbs., case count 1,000; Other soft and hard candies: 10 lbs., case count 1,000; Small Tins: 8 lbs., case count 100 tins; Star Tins: 10 lbs., case count 100 tins; Heart Tins: 10 lbs., case count 100; Hospitality Packs: 10 lbs., case count 200 packs; Window Pouch Bags: 10 lbs., case count 24 bags.

FOB: North Carolina all products

CLASS: Individually wrapped candies-Custom 2PQR3S, Stock 3P3QR, except stock Starlites, 2P5R; Tins-R; Hospitality Packs-R; Window Pouch Bags-2P2R.

NORMAL PACKAGING: Individually wrapped in white pearlescent film printed with one color.

SPECIAL PACKAGING: Gold, Silver, and Tinted film add \$10.00 (V) per case.

Two and three color imprint, second side imprint, and PMS match available for 10 case minimum (color separations required).

CUSTOM IMPRINTING: Individually Wrapped Candies & Hospitality Packs add \$60.00 (V) per color for one time plate charge. Reorder-Setup fee \$10 (V) per color. Tins add \$60.00 (V) per order for one time plate charge. Reorder fee \$10 (V) per order. Window Pouch Bags with customized gift tag add \$60.00 (V) per order for one time plate charge. Reorder-Setup fee \$10 (V) per order.

METHOD OF IMPRINTING: Hot Stamp and Flexography

IMPRINT COLORS: Standard ink colors-Black, Blue, Brown, Bronze, Burgundy, Gold, Green, Lime Green, Orange, Pink, Purple, Red, Silver, Navy Blue and White. PMS match available at no charge for 10 or more cases. PMS match may be up to two shades off, we can not guarantee perfect match.

***INACTIVE PLATES:** Inactive plates are discarded after 18 months and a new plate must be ordered.

WRAPPER COLORS: Standard wrapper colors-No Charge-White and Clear (must be specified). Tinted wrapper colors-Add \$10.00(V) per case Aqua, Black, Light Blue, Navy Blue, Royal Blue, Burgundy, Lime Green, Metallic Gold, Hunter Green, Kelly Green, Ivory, Pink, Purple, Red, Metallic Silver, Yellow, Brown and Orange.

NORMAL COPY LIMIT: Hotstamp: 1 1/2" x 3/4"; Small Tins: 1 3/4" x 1 1/2"; Star Tins: 1 1/4" x 1 1/2"; Heart Tins: 1" x 3/4"; Hospitality Packs: 2" x 1 1/2"; Flexography: Large wrapper can be used for all flavors. Front- 1 1/2" x 3/4", Back-above seam-1 1/2" x 3/8", Back-below seam-1 1/2" x 1/8"; Flexography: Small wrapper only used for starlites. Front-1" x 3/4", Back-above seam-1" x 3/8", Back-below seam-1" x 1/8"; Window Pouch Bags Gift Tag: 2 1/4" x 2 1/4" per panel.

ARTWORK: Camera ready art is required. Color separations must be provided for two and three color imprints. Electronic files must be PC format .ai, .eps, .cdr, or .tif. When sending us art, please reference your PO# and include all company information. FREE paper proof upon request for new custom orders, please provide email address or fax number where to send proof to. **Email artwork to art@hospitalitymints.com**

POLY BAGGING: Allows you to divide cases, control usage, and provides refill inserts for fulfillment programs. Bag counts available: 50, 100, or 125 (polypropylene/clear film); 250 or 500 (polyethylene/cloudy-like film) 1 to 9 cases: \$1.10 (P) per bag; 10 cases or more \$0.90 (P) per bag. Leadtime: reorders 12 working days plus shipping. New orders 14 working days plus shipping after receipt of order and approved art.

SPECIAL RESTAURANT & HOTEL PRICING: Call Customer Service for details.

SPEC SAMPLES: Individually Wrapped Candies \$130 (P) includes 50 pieces of candy, white wrap and one standard color imprint. Price increases to \$150 (P) for tinted wrapper color. For a two or three color imprint add \$60 (V) plate charge per color. Tins \$50 (P) includes 6 small, 6 star, or 6 heart four color process printed, filled and shrink-wrapped tins. Hospitality Packs \$130 (P) includes ten packs with five candies per pack, white wrap and one standard color imprint. For a two to three color imprint add \$60 (V) plate charge per color. Window Pouch Bags \$50 (V) includes 2 bags with custom imprinted gift tag.

METHOD OF PAYMENT: Credit Card, Check or C.O.D. Prepayment required for first time order either by check or credit card.

CANCELLATION POLICY: Once an order has been confirmed it may NOT be cancelled. Payment is expected on any confirmed order.

RETURN POLICY: NO returns are allowed without prior approval from Hospitality Mints.

We need your email address for order confirmation and order tracking notification.

*Prices, minimums and terms are subject to change at the discretion of the manufacturer.

2009

HospitalityMints®

The perfect compliMINT, all wrapped up!

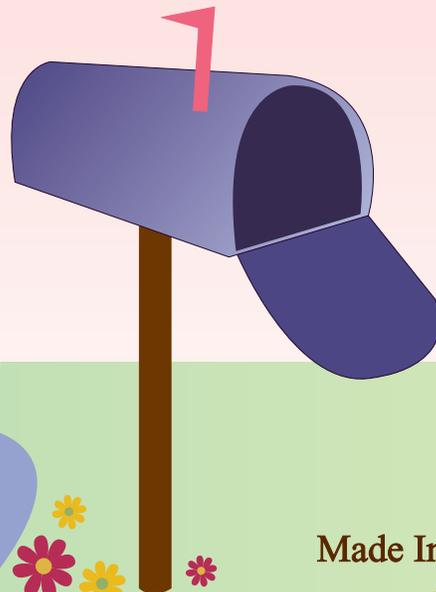
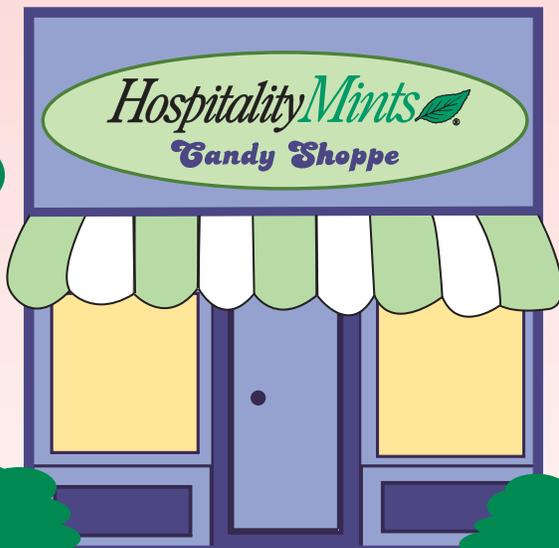
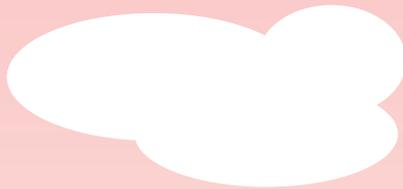
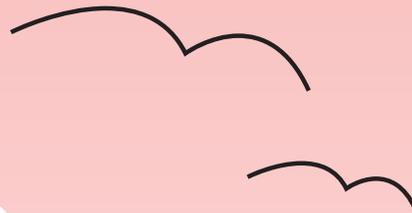
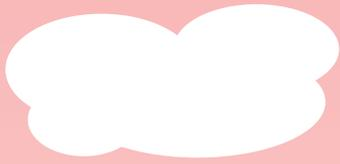

Made In America 

